

Varenummer: 40550300392440  
 Beskrivelse: Tandhjulsgeaer S301F-3,9-P100B5

## Mål

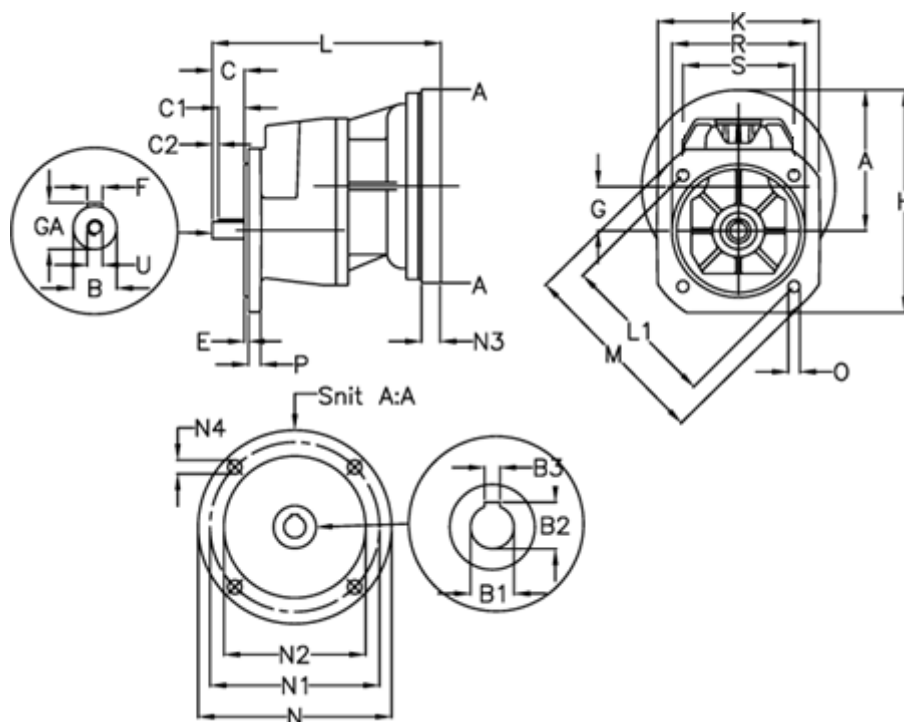

A = 122.8	E = 3.5	M = 200.0	R = 130
B = 24	F = 8x7x40	N = 250	S = 130
B1 = 28	G = 51.8	N1 = 215	U = M8
B2 = 31.3	GA = 27.0	N2 = 180	
B3 = 8	H = 197.8	N3 = -	
C = 50	K = 150	N4 = M12x16	
C1 = 40	L = 262	O = 11.5	
C2 = 5	L1 = 165.0	P = 12	